



CAUTION!

These instructions must be read and understood before installation, adjustment, service or maintenance.

Operations and Maintenance,
Instructions of shipment, unpacking and installation.

Terrace awning Jupiter

• **General scheme of terrace awning**

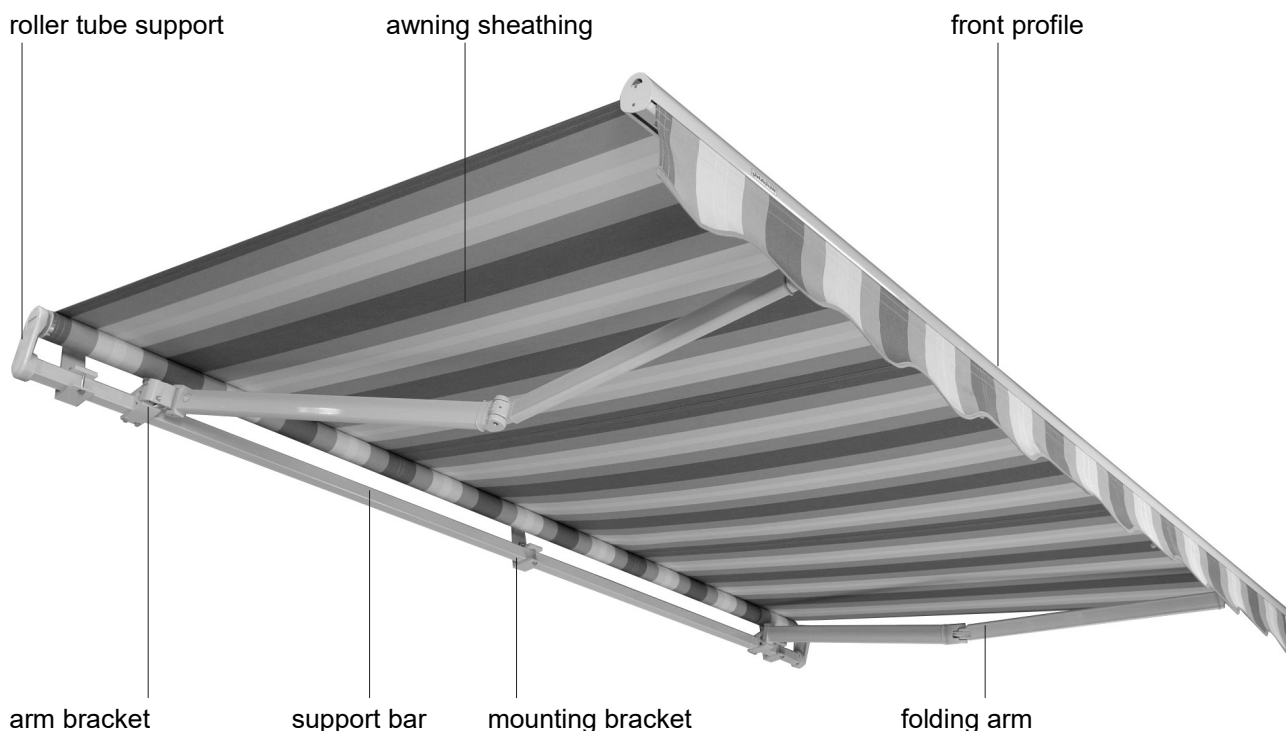

- Steering:
 - [] Manual,
 - [] E-drive,
 - [] Motor drive with NHK

• Data of electric drive:

Power W, Voltage 230V;
Frequency 50Hz;

• YOC:

• Serial Number:

.....
<p><i>EN 13561</i> External blinds Class of wind resistance:</p>

- **Content**

1. Introduction
2. Instructions for use and maintenance
3. Transportation, unpacking and installation instructions

1. Introduction

- These installation instructions are an integral part of the terrace awning and was written for the professionals of the installation company and for the end users.
- An additional instruction for the electric products will be attached to this manual and should be treated as an integral part of this instruction.
- Add, remove, or change the content of this manual not permitted.
- The installation instructions must be kept and be easily accessible by the whole use time of the awning.
- Please read the installation instructions, and the other instructions that are attached to the product before unpack, installation and use of the product.
- This document has been prepared according to requirements of the standard PN-EN 13561:2004+A1:2008.
- Explanation of symbols used in this manual:



Important Safety Information!

Notes and general remarks on the safety use. Improper use of awnings can have a negative impact on the awning structure and a loss of their properties and thus lead to the deterioration of security.



CAUTION!

The warning triangle shows the important tasks in the operation, maintenance, etc. Failure to comply with the recommendations may result to the accident.

Important Safety Information



CAUTION!

For the safety of people, it is important to read this instructions before the Installation and followed. The installation instructions must be stored and must be passed by eventual resale of the awning to the new owner. In case of loss or damage to the installation instructions you should immediately contact the dealer for a copy.



Note

- By working at height should be applied appropriate security measures to protect against accidents.
- Ladders or scaffolding must be set on a stable surface.
- You should have appropriate qualifications to work at height.

2. Use and Maintenance instruction

2.1. General



CAUTION!

For the reasons of safety, installation, maintenance and use of awnings, please follow the following guidelines.

- The installation of the awning should be done by an authorized dealer.
- Modifying the construction of the awning are not allowed.
- The arms are under high spring tension. Do not try uncouple of the spring arms.
- It is not be allowed to under awning be during maintenance or installation work.
- Follow rules and instructions on health and safety during installation and maintenance.
- Handle uncouple after use.
- Do not use an awning near an open flame.
- Use the manual control of awnings with drive in emergency only.
- Do not overload an awning construction.
- Roll up the awning in bad weather such as frost, snow, rain and hail.

2.2. The right use

Awning is designed to protect against sunlight. The System allows the user to unroll or roll up her as necessary.

- For a manual control, the system based on a crank and gearbox.
- By turning the handle in both directions, an awning can be roll up or unroll.
- By folding arms awning turn the crank until the awning sheathing will be tight enough. It is not allowed to unroll the fabric from the roller tube completely.
- For the Electric drive the system is made of an electric motor and a control switch (it can a wall switch, remote control, and/or weather automatic be).

The Awning is not designed for the other purposes (eg. protection against other weather conditions).



CAUTION!

Roll up the awning in bad weather such as frost, snow, rain and hail.

2.3. Information regarding products with electrical supply



CAUTION!

Do not leave children alone with the device that controls the awning. Keep the remote control away from children..

If the awning is equipped with an electric motor or lighting, the manual provides:

- An electric circuit diagram that can be used during the installation, together with assembly instructions.
- Certification of electrical components delivered for the awning.



CAUTION!

One should check the electrical wiring two times a year for signs of wear or damage to the cable. Do not use if they need to be repaired.

- Always switch off the power supply before making any maintenance work.
- Switch should be placed in such a place where we can see the awning position in any movement.
- Switch should be located away from moving parts.
- Switch should be installed at a height according to the regulation for the disabled persons (generally less than 1,30 m).
- If manual drive is possible, it should be installed at a height of less than 1,80 m.
- Keep the electrical switch away from children.
- If the switches are located on the outside, it should have IP55 protection class or higher.

In an area with high wind intensity that is exposed to a frequent power cuts, we recommend to use an alternative energy source, or to use a handle.



Note

The fabric during the operation, at the different temperature and humidity, can easily change of its size. It may necessary be limit switch to set again, especially for the cassette awning. This is a service action and is not the basis for the complaint.

When it comes to awnings that can be to switch on out of the sight, the user should take the appropriate organizational measures so as to prevent unintentional switching of the awning during maintenance or repair work, eg window cleaning or wall cleaning.

To carry out inspections or maintenance, an awning must be safely disconnected from the mains electricity.

It is not allowed to make changes to the configuration of the electrical equipment.

An awning noise shall not exceed 70 dB.

2.4. Maintenance of awning

2.4.1. Scheduled maintenance of the fabric

Turn off the power supply.

Cleaning of the fabric depends on the type of fabric, it is recommended to use the vacuum cleaner, wet sponges or cleaning agent recommended by the manufacturer. To clean the awning safely, should not use ladders or scaffolding. If necessary, use a garden hose or tools with handles (vacuum cleaners, sponges with handles, etc). Before the awning will be roll up, wait until it is completely dry. A visual assessment of fabric at least twice a year For further information see the manufacturer description of the awning.



CAUTION!

Do not use solvents, ammonia, or any other chemicals.

2.4.2. Scheduled maintenance of the awnings frame

Scheduled maintenance consists of the following steps:

- Check regularly that all screws and bolts are properly tightened;
- Check regularly whether wall brackets are holding correct,
- Moving parts lubricate with silicone grease;
- Regularly check electrical cords.
- Regularly check that awning is not polluted by leaves, snow or dirt.
- Regularly check the position of the protective rubber rings on the folding arms to prevent scratches.

3.4.3. Unscheduled maintenance of the awnings frame

Unscheduled works may only be performed by qualified personnel (eg replacement of parts or fabric,etc), if it necessary.

3.5. Disassembly and disposal

Disassembly of the awning must be performed by qualified personnel. Awning contains no hazardous components. Turn to recycling company to reduce the negative influence of waste over the natural environment.

3.6. Important notes and warnings

**CAUTION!**

Roll up the awning in bad weather such as frost, snow, rain and hail.

**CAUTION!**

If the awning will be used during the frost it can damage your awning.

**Note**

Possible buckling of the fabric. If the sheathing is not on the arms of the awning it can not be a complaint. In the vicinity of the seams and the edges of the sheathing can form folds and wrinkles - it is natural.

**CAUTION!**

In case of fault you should refrain from further usage and immediately contact the installation company.

**Note**

Stainless steel parts in the event of exposure to external conditions can corrode in a limited way.

**Note**

Unroll the fabric of the awning in the wrong direction may damage sheathing and structures of the awning.

**Note**

The sheathing may have slightly different color (if coming from different production types)

**CAUTION!**

- It is not allowed to hang, hook or put anything on the awning.
- It is not allowed to hang or placed something on the awning.
- Adjustment and repair of awnings by unauthorized persons are not allowed.

**CAUTION!**

Installation of awnings with electric drive in hazardous environments or where very large quantities of flammable substances in the air is not allowed.



CAUTION!

At angle of inclination of the awning at less than 14°, even during light rain, the awning must be roll up in order to prevent the damage caused by the bad weather conditions.



Note

Fabric in the terrace awnings is narrower (from 10 to 15 cm) than the total width of the awnings frame; depending on the type of drive, from 10 cm to 15 cm.

Do not dispose of electrical components in the trash. It must be deliver to the point of disposal of electrical equipment.

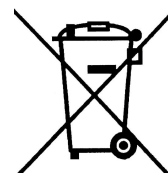

3. Instructions of shipment, unpacking and installation

3.1. Delivery

- 1x Terrace awning Type: Weekend EVO,
- Brackets ordered in accordance by the Type (Wall-, Ceiling- or Rafterin an amount according to the Table:

Dimensions (cm)	Depth: 220 - 365	Depth: 366 - 480	Depth: 481 - 600
Width: 150 - 200	2	3	3
Width: 250 - 350	2	3	4

- 1x Service Manual,
- 1x Operating and Maintenance Instructions, Warranty,
- 1x E-Connections and settings (for motor drive),
- 1x User manual for Weather Automatic (only for Awnings with Sun-Wind Automatic),
- 1x Remote Control (only for remote controlled Awnings),
- 1x Handle (only for Awnings with manual drive or with motor drive Type: NHK),
- 1x Test run or programming cable (only by special order),
- 1x Handing over protocol/Warranty.

3.2. General remarks



Note

The awning is supplied without mounting material. The components of the awning meet the applicable rules and technology. Changes in the design are allowed only with permission of DRAGON, Korgul, Prochowski Sp. J. Changes in the design of the awning without the written consent of the manufacturer could void the warranty.



Note

Installation of awning, adjustment and checking of proper operation can be performed only by trained installation teams. Installation team is responsible for correct installation (with the appropriate anchors for the basis) readjustment and test run of the awning.

3.3. Service, shipment, unpacking and storage

The awning is so packed that it can be delivered without damage. During loading and unloading of the awning be sure it was not placed on an uneven surface. We recommend carrying this awning by two people. Upon unpacking the product you keep a special care not to damage the fabric.



CAUTION!

Do not remove tapes from the folding arms of awning earlier than specified in this manual.

If the awning will be stored for a long time, before installing we recommend:

- Store the awning in the shade.
- Protect the awning from moisture and high temperature difference.
- Protect an awning from shock and/or load.

3.4. Installation of the awnings frame

**CAUTION!**

Installation of awning or adjustment can be made only by trained installation team.

The installation must be in accordance with the requirements of safety, particular in health and safety regulations. Use scaffolding or ladders that are in good condition. If the awning is not installed on the ground floor but on the upper floors, it is recommended to mark up and protect the area below. Do not make changes in the structure of the awning.

3.5. Qualifications of the installation team

- Observe safety rules.
- Ability to use of ladders and scaffolds.
- Ensure transport and storage of the awning.
- Experience in the use of tools and equipment.
- Appropriate certificate of approval and use for fixing materials in construction.
- Installation training at Dragon company (recommended).
- Training the end user before using the awning.
- Pass manuals and warranty on the end-user.

**Note**

Installation of the awning, adaptation and check the proper functioning can only be done by trained installers team. This team is responsible for the right installation (with the anchor bolts) readjustment and test run of the awning.

3.6. Fastening and pulling on the ropes

If you need to pull the awning in a higher level with the aid of ropes must one:

- Take out from the packaging.
- Transport ropes must be fastened so that the awning can not slip out.
- Uniform load distribution (in horizontal position) during the pulling out.

3.7. Required tools

- Ladders / Scaffold,
- Level,
- Ropes,
- Measuring tape,
- Impact drill and drill bit (depending on the substrate),
- Imbus (3mm, 5mm, 6mm),
- Wrench / ringspanner (SW10),
- Socket wrench, extended (SW13),
- Tools for the chosen installation method (type of anchor, etc).

3.8. Installation steps

**Note**

Installation of awning or adjustment can be made only by trained installation team.

- 3.8.1. Check the delivery.
- 3.8.2. Mark and fix the mounting brackets.
- 3.8.3. Drill a cable conduit for electric line (only for motor drive).
- 3.8.4. Awning hang on the mounting brackets and secure it.
 - 3.8.4.1 Awning Installation with the Hood (if ordered).
 - 3.8.4.2. Awning Installation without the Hood (Standard).
- 3.8.5. Awnings pitch angle adjust.
- 3.8.6. To set up the front profile.
- 3.8.7. Turn on an electric installation (only for motor drive).
- 3.8.8. Handle (only for Manual drive or Motor drive with NHK)
- 3.8.9. Check the unit.
- 3.8.10. Training and information the end user before using the awning.
- 3.8.11. Handing over all the necessary instructions and warranty the end user and pass the awning for use.

3.8.1. Check Delivery

Before beginning the installation should be checked:

- Check that the information given in the order of: awnings, color and pattern on the fabric, frame color, type of drive (handle/motor), drive side and the other product features are consistent with the delivery.
- Number and accuracy of the delivered parts.

3.8.2. Marking and fixing of the mounting brackets

**CAUTION!**

In order to avoid the risks associated with moving parts of the awnings, device must be installed at such a height that the lowest moving part will be at least 220 cm from the ground.

Awning is supplied with brackets for installation in wall, ceiling or roof rafters - in accordance with the contract.

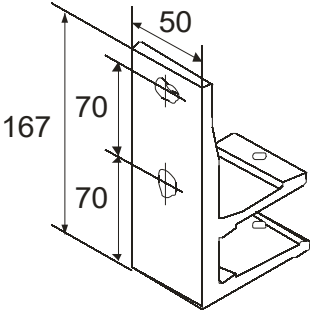
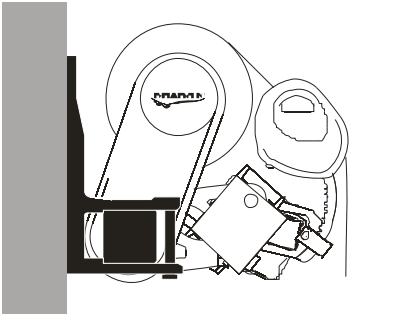
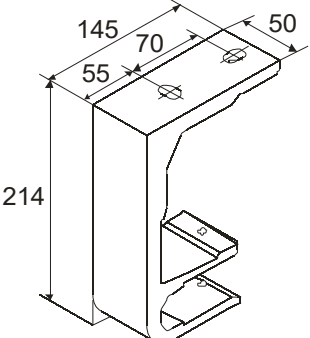
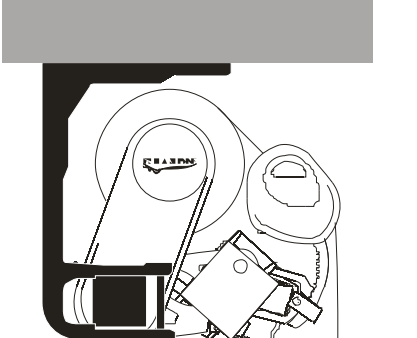
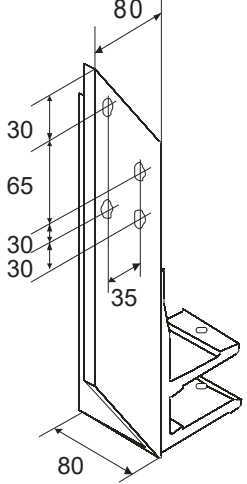
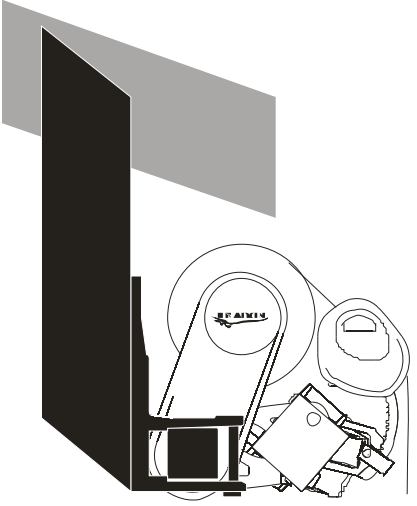
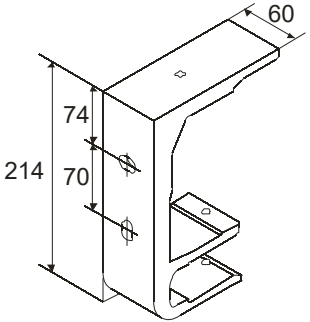
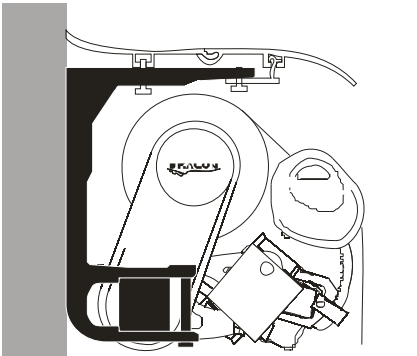
Type od installation	Mounting brackets	Installation Scheme
Wall-		
Ceiling-		
Roof rafters - (wall mounting brackets + adapter)		
Wall assembly with hood		

The awning meets the wind class rating when the manufacturer's recommended number and type of the mounting brackets were mounted with the correct mounting anchors. Before starting installation make sure that the mounting surface is suitable for the mounting – if were found the deviations of the surface strength, then order more mounting brackets - (number of mounting brackets ,in standard, for Wall mounting Concrete C20/25).

- Mark the brackets and drill the holes (position of the brackets in the following figure and description:

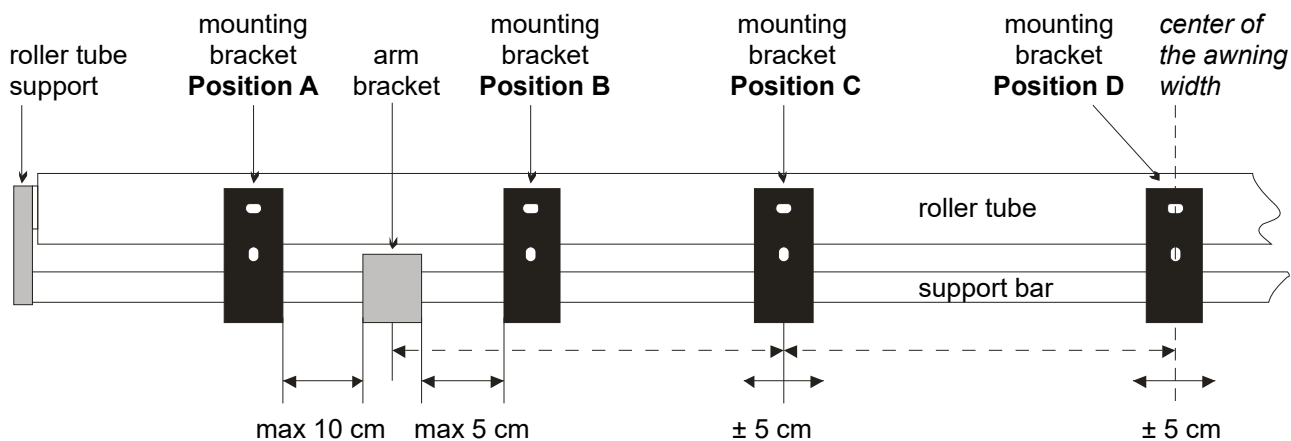

2 brackets - both brackets should be placed at a distance of not more than 10 cm from the outer edge of the arm bracket (**position A**), symmetrically on both sides of the awning. If between the arm bracket and the roller tube support there is not enough space, the brackets should be placed no more than 5 cm from the inner edge of the arm bracket (**position B**), symmetrically on both sides of the awning.

3 brackets – two brackets should be placed at a distance of not more than 10 cm from the outer edge of the arm bracket (**position A**), symmetrically on both sides of the awning. If between the arm bracket and the roller tube support there is not enough space, the brackets should be placed no more than 5 cm from the inner edge of the arm bracket (**position B**), symmetrically on both sides of the awning. One of the brackets should be placed in the middle of the width of the awning (**position D**) with a deviation of 5 cm or when a holder of the roller tube (item 3.12 pos. 29) is in the middle next to it.

4 brackets - two brackets should be placed at a distance of not more than 10 cm from the outer edge of the arm bracket (**position A**), symmetrically on both sides of the awning. If between the arm bracket and the roller tube support there is not enough space, the brackets should be placed no more than 5 cm from the inner edge of the arm bracket (**position B**), symmetrically on both sides of the awning. The other two brackets should be placed, symmetrically on both sides of the awning, between the arm bracket and center of the awning width (**position C**).

5 brackets - two brackets should be placed at a distance of not more than 10 cm from the outer edge of the arm bracket (**position A**), symmetrically on both sides of the awning. If between the arm bracket and the roller tube support there is not enough space, the brackets should be placed no more than 5 cm from the inner edge of the arm bracket (**position B**), symmetrically on both sides of the awning. The other two brackets should be placed, symmetrically on both sides of the awning, between the arm bracket and center of the awning width (**position C**). One of the brackets should be placed in the middle of the width of the awning (**position D**) with a deviation of 5 cm or when a holder of the roller tube (item 3.12 pos. 29) is in the middle next to it.

Another brackets - should be symmetrically, taking into account the fact that the biggest load of support bar are around arm brackets.

- Check holes in the wall with the level and plumb-line.
- Each brackets were mounted with appropriate fasteners. For the surface made of concrete C20/25 use an approved anchors M12.

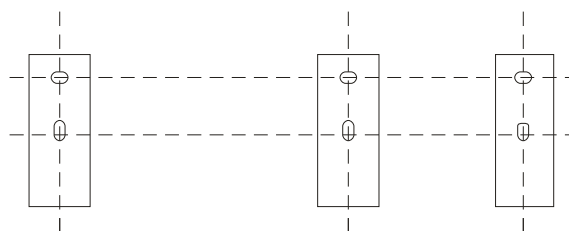
**Resistance force data:**

Permissible tensile load:

F (kN) \geq C20/25: 5,70

Permissible in the concrete compression zone:

F (kN) \geq C20/25: 6,50

Permissible bending moment:

M (Nm): 28,3

The other parametres as for the equivalent WTC – anchor, a series of 904 112 by WURTH.

For assembly to the roof rafters use screws right to the material of which the rafters made are.

**Note**

When selecting the mounting means that the maximum load on the awning at Windclass 1: 75N/m² ist; and at Windclass 2: 100N/m². In addition, you will be taken into account the weight of the awning.

3.8.3. Laying electric cables (if motor drive was ordered)

- Drill out grommet for electrical conduit. Power to the motor drive should be prepared in accordance with the relevant provisions.

3.8.4. Awning into brackets hang and secure**3.8.4.1 Awning Installation with the Hood (if ordered)****Note**

Awning is heavy and bulky. Make sure that the number of people is sufficient to mount the awning to its size and weight.

- Install hood before the awning is hang in brackets.
- Screws M6/25 (the number of screws according to the number of brackets) insert in the Profiles hole "X".
- Profile "X" into brackets hang, the screws through the holes insert and then tighten.

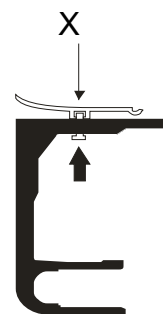

- Screws M6/16 partial tighten (on 2 grooves on the thread)
- Hang the hood front profile „Y” in the profile „X” mounted in the bracket.
- Clamping plates „Z” into profiles hole Z insert.
- Clamping plates „Z” hand out for all brackets.
- Clamping plates „Z” do not tighten, until the awning has been mounted on brackets, so that Profile -"Y” can be hang.

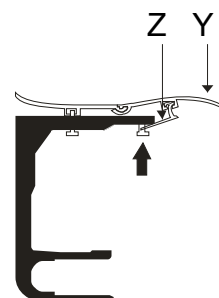

- If the awning were hanged in brackets, the hood Profile "Y" must be raised enough to easily put up the awning in the brackets.
- Awning put up in the brackets and insert supporting tubes in the lane.

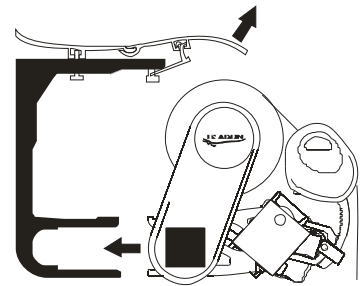

- Awning in brackets secure with screws M8 using a wrench/ring spanner Nr5.
- Bring hood profile "Y" down.
- Clamping plates „Z” tighten.
- Screw on the hood with the enclosed screws.

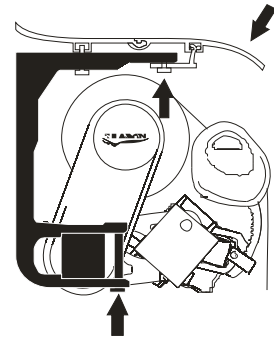

3.8.4.2. Awning Installation without the Hood (Standard)



Note

Awning is heavy and bulky. Make sure that the number of people is sufficient to mount the awning to its size and weight.

- The awning hang in the console and insert the support tubes in the mounting hole.
- Awning with brackets secure with screws M8 using allen key Nr 5.

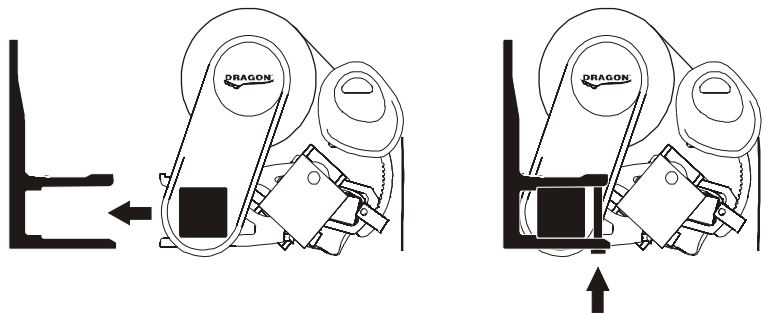

3.8.5. Pitch Angle Adjusting

Adjust the pitch angle the awning, so that the minimum height from the ground was not less than 220 cm.



Note

If a pitch angle the awning has less than 14° it is necessary to roll up device in case of a rain as this could damage the awning construction.



CAUTION!

The Arms are under extreme tension. Risk of personal injury!



CAUTION!

Pitch angle progressively regulate for all arms so that they do not lead to significant differences in the settings.



Note

Work will be performed on each arm. This work must be carried out by two people.

- Unroll Awning to the end to get the awning fabric taut.

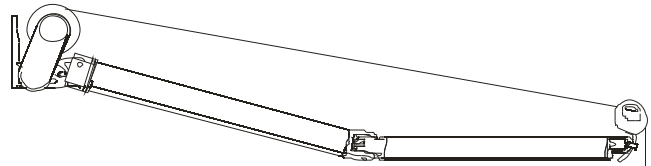

- Screw "B" loosen until he comes back inside the cylinder A (loosen screw "B " not more than illustrated in pictures).

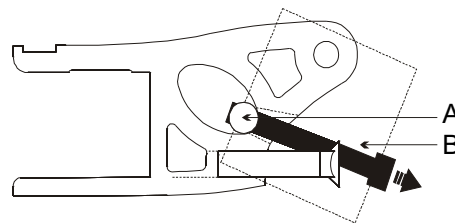

- Person "1" - hang arm so the mounting bracket do not presses screw. Hold in this position.

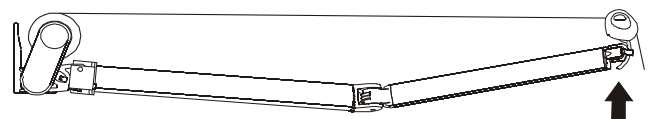

- Person "2" – screw on „C" for the new position of the screw to set (unscrew the screws of more than 3,7 cm).

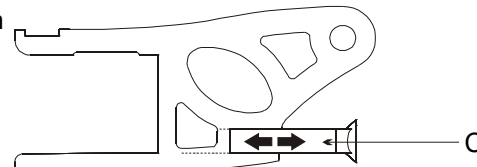

- Person "1" – the arm bring down, holding on, slowly put the arm on the screw "C".

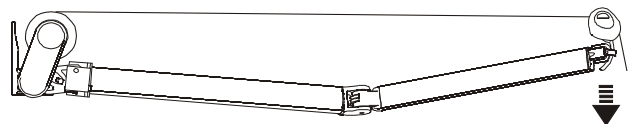

- Person "1" – if awning arms are adjusted with a level, check the horizontal position of the front profile. If it's necessary adjust it again.



WRONG



RIGHT

- Person "2" – if desired pitch angle is achieved, tighten the screw "B".

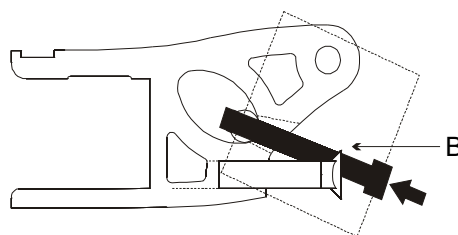

- After changing the pitch angle of the arms, the front profile requires the setting. Description of the system below.



Note

In order to prevent an accumulation of water from the rain in the fabric (a water bag forming), it is necessary to set by fully opened awning a pitch angle on more than 14 °. Through the formation a water bag can cause damage to equipment and danger to people. Awning is a product that is designed to protect against the sun. You can only use it in light rain.

3.8.6. Front profile adjust



Note

If the pitch angle of the awning arms has changed must be readjust. Inappropriate front profile settings can lead to structural damage or injuries.

- Measure the length of the visible part of the screw "C" in the arm bracket.

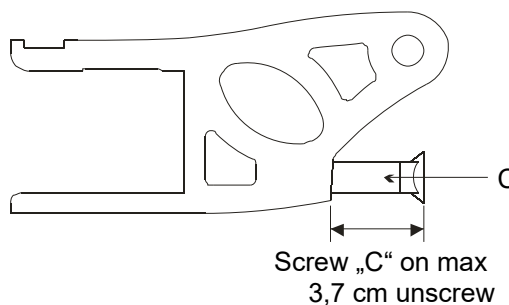

- Set the front profile according to table below:

Slit E	Screw „C“ unscrew to:
1 (upper)	3,7 – 3,39 cm
2	3,39 – 3,08 cm
3	3,08 – 2,77 cm
4	2,77 – 2,46 cm
5	2,46 – 2,14 cm
6	2,14 – 1,83 cm
7	1,83 – 1,52 cm
8	1,52 – 1,21 cm
9	1,21 cm – 0,9 cm
10,11	not used

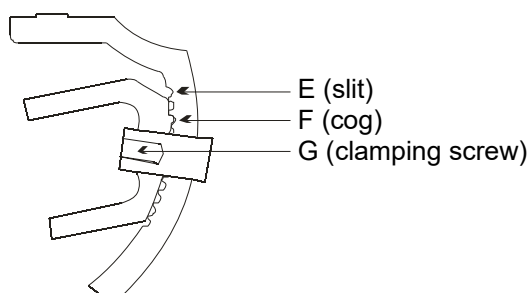

- to set in accordance with the table above.

- Fabric awning unroll till it drops to arms(for motor drive must set end point position).

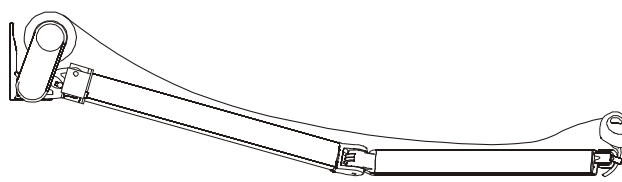

Fabric awning drops freely

- Unscrew the Clamping screws „G” on all arms.
- Set the slope at the cog "F" in any arms at the same slit "E".
- Be sure that the cog "F" into the slot "E" well matched.
- Fix all Clamping screws "G" tighten. During the tightening subtend all elements (s. Figure).

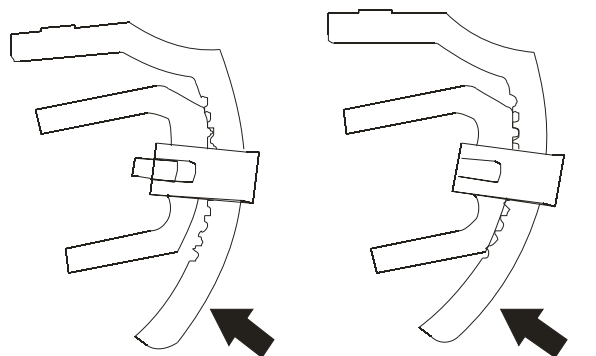

Subtend selected elements

Hold in this position and fix Clamping screw "G"

- Awning fabric tense, then check the front profile position (if necessary, change the final point position according to the motor drive manual).

3.8.7. Awnings engine plug in to power (if Motor ordered)



CAUTION!

The electrical connection must be made by a licensed professionals. Electrical cables connect as described in the attached schematic. The awning may be connected only if the information on the rating plate agree with the power source.

When installing the motor cable make sure that no creases and sharp edges on the cable line. The uninterrupted operation of the motor driven by electrical outlet is not allowed! The switch of the awnings should be installed at a height of 125 cm and must be locked for off and on position, otherwise the end point position is lost. The unroll and rollup limits are the factory setting. After changes to the settings, save them according to description in manual.

- End point position of the motor.

To make a change in the end point position, use the description of supplied motor.

When weared or damaged cables, do not use awning and repair by a licensed professionals.

3.8.8. Using handle (only manual drive or motor drive with NHK)

- Awnings handle into the loop of the gearbox. By turning the handle can open or close the awning.
- Awning fabrics must be roll up on the right side (from top) otherwise it can damage the sheathing and the awning.

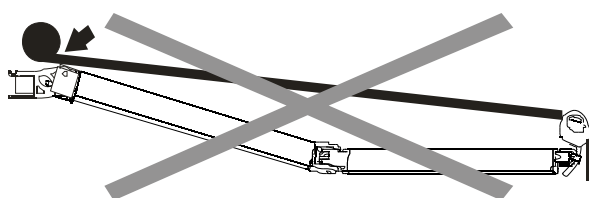

WRONG

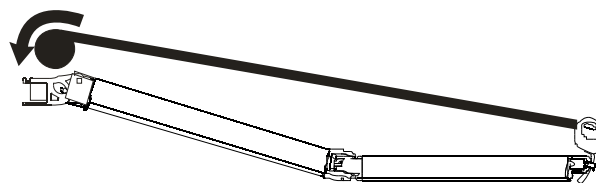

RIGHT

3.8.9. Check the awning after installation

After installation, check items from the list below:

- Operation (manual or electric).
- Stability.
- Proper operation of limit switches.

3.8.10. Training and instruction of the end user before awning in use

Installation team must fully inform the end user about safe use of the awnings.

3.8.11. All manuals, as well as installation and setting instructions of the motor, switches and controllers must be given to the user

After assembly, the person in charge of the installation team must sign The handing over protocol/Warranty. According to knowledge of local conditions and after completion of the assembly, installation team declares the user whether the manufacturer's wind class was achieved. If not, the installation company must to document the actual achieved wind class rating. It should be also give in the document the setting of the screws "C" - see section 3.8.5 of the manual. (Changes can be made only by a trained installation team. Changes confirm with stamp and signature).

The handing over protocol must be countersigned by the user and installation team.

After assembly the following instructions must be passed to end user:

- Installation manual.
- Service and maintenance manuals and warranty (with wind class of the awning).
- Settings (only for motor drive).
- Sun and wind automatic instruction (only for awning with automatic).
- Remote Control Guide (only remote controled awnings).
- Handing over protocol/Warranty.

3.9. Repair the awning

Repairs should be carried out only by a specialist. Only spare parts from DRAGON can be used.



CAUTION!

The Arms are under extreme tension. Risk of personal injury!

3.9.1. Replacement a drive

In order to make a repair to a defective drive, the awning must be using a belt secured. All the necessary work can be made only by a specialist. The drive must be the same series and by the same manufacturer are.

3.9.2. Replacement of the sheathing

For this action must be the awning removed. The change must be made by an authorized dealer or the awning must be sent to the manufacturer to replace the sheathing.

3.9.3. Replacement of the components

The change must be made by an authorized dealer or the awning will be sent to the manufacturer to replace the item.

3.10. Start-up

Any person can't stay in the area of the awning during the test run. All items located under the awning must be removed. The remote control can be used only if the user see the awning in the whole range of its movement. All equipment should be stored out of reach of the children.

In the awning were used special arms they change the pitch angle by rolling. This made a compact device.

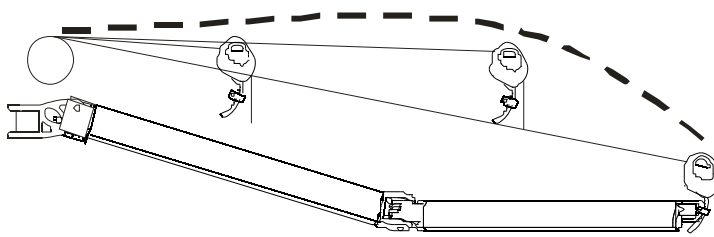

The pitch angle of the awning is the angle between the plane of the sheathing for maximum unrolled awning and the horizontal plane. Decreasing of the pitch angle when awning will be unrolled, is natural.

3.11. The scope of the wind sensors

In strong gust of wind or the incorrect setting of automatics can cause damage and for this the manufacturer is not liable.

3.12. Assembly drawing of the awning

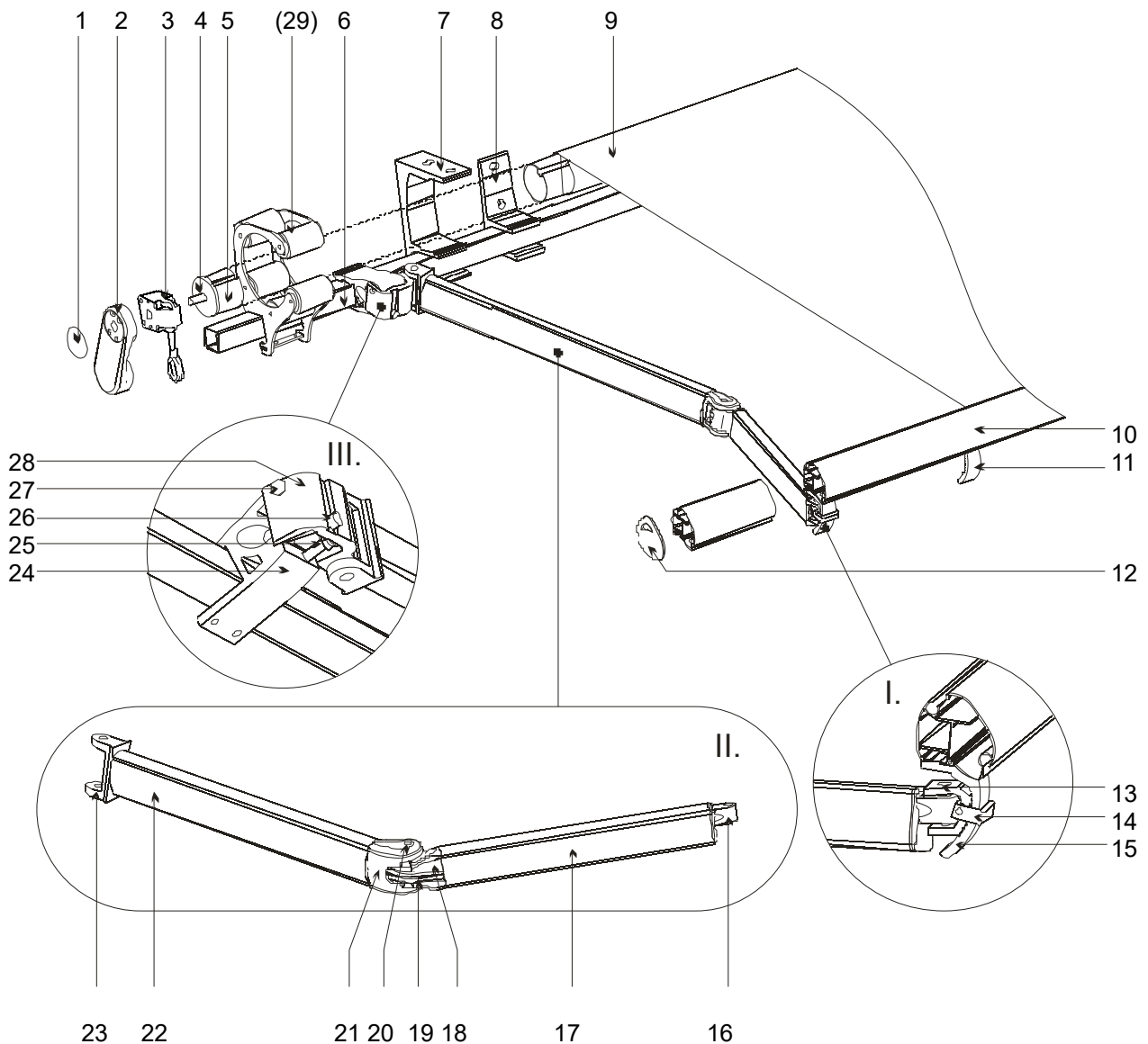

1. label
2. roller tube support
3. gearbox of manual drive, if ordered (on the left or right side of the awning)
4. end of the roller tube or mounting position of the electric drive
5. roller tube
6. support bar
7. ceiling bracket
8. wall bracket
9. sheathing
10. front profil
11. bumper
12. front profile cap
- I. Adjustment knob of the front profile**
13. part of the adjustment handle of the front profile (contains the cog F)
14. safety pin (with Allenscrew G)
15. part of the adjustment knob of the front profile (contains Slit E)
- II. Arm**
16. lower end of the arm
17. lower profile of the arm

18. lower part of the hing
19. cables
20. adjustment screws
21. upper part of the hinge arm
22. upper profile of the arm
23. upper end of the arm
- III. Arm bracket**
24. adjustment handle of the arm
25. adjustment screws C
26. adjustment screws B
27. screw (do not use!)
28. arm holder
29. roller tube holder

Grants for Innovative



UNIA EUROPEJSKA
EUROPEJSKI FUNDUSZ
ROZWOJU REGIONALNEGO



The service is supported under Measure 6.1 (Passport to Export) Priority 6 of the Polish economy on the international market, Innovative Economy Operational Programme 2007-2013 under the provisions of the Regulation of the Minister of Regional Development of 7 April 2008 on the granting by the Polish Agency for Enterprise Development of financial support under the Operational Programme Innovative Economy 2007-2013 (Journal of Laws No. 68, item 414, as amended.). Project title: "Development of export of Company Dragon through the implementation of the Export Development Plan." Grant Agreement Number: UDA-POIG-06.01.00-22-194/11-00